

# Developments in Receiving System Integration Techniques

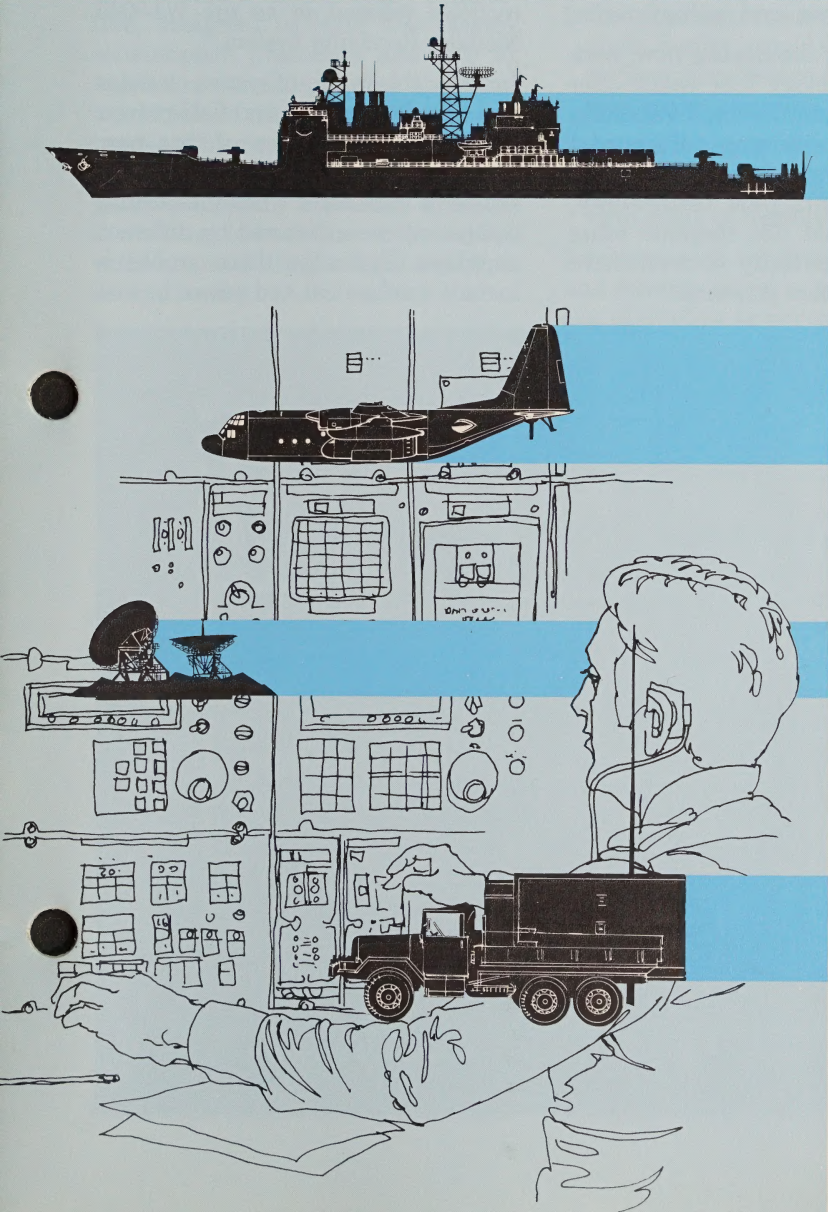

WATKINS-JOHNSON COMPANY

# Tech-notes

Developments in the military and intelligence community requiring automated receiving systems are placing increased technical cost and schedule demands on today's system integrators. As a result, Watkins-Johnson Company has taken a lead in the growing number of communication equipment manufacturers, placing considerable emphasis on alternatives to current practices in signal acquisition, monitoring, and analysis for use in C<sup>3</sup>I systems and sub-systems.

The process of developing new, cost-effective technology that would offer an order of magnitude improvement in the functional performance of proposed acquisition systems continues. The absence of this new technology, however, should not stagnate other new and potentially cost-effective system integration practices.

What has evolved is a unique technical approach affecting system architecture, command and power considerations. This new approach is part of an ongoing design effort by Watkins-Johnson to assist integrators in the rapid deployment of today's communications systems. Figure 1 illustrates an example of a small collection system built using components which utilize a unified design approach. These components are part of a family of system modules referred to as the WJ-9040 Modular Receiving System.

Initially, this family of system modules was based on in-place and field-proven technology. The focus of this new approach is to simply address those problems introduced when integrating equipment manufactured by different suppliers. Typically, these problems include mechanical and power incom-

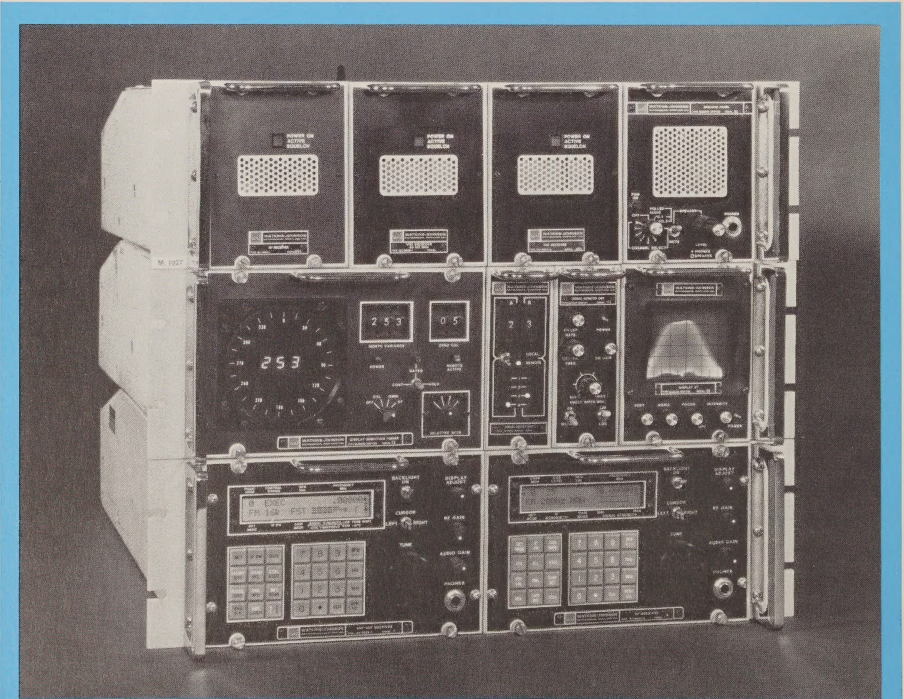

Figure 1. An example of a three-frame communications system which eases integration problems through the use of a unified-design approach based on modules which are compatible in mechanical architecture, power requirements, and control structure.

patibilities as well as control and data inconsistencies. With a unified design, however, a desired subsystem which is user-controlled and easily reconfigured or expanded is readily available. As new technology becomes available, the means for updating a system is also provided.

In other words, a collection of compatible system components, modularized to a common or "unified" architecture that is mechanically compatible, designed to rigid low power-consumption guidelines and able to support a versatile control structure, would relieve the system integrator of many problems relating to size, power and control disparities. These disparities typically represent a costly investment of both time and material without contributing to the integrators desired results.

For the purpose of comparison, the typical electronic collection system's tasks, beginning with an operational requirement or known threat, leads to the following generalized actions:

1. Preparation of a system specification
2. System conception (configuration, mechanical and electrical design)
3. Definition and selection of individual system components
4. Development of special units not available
5. Development of control and applications software
6. Integration and test
7. Documentation (engineering drawings, manuals, etc.)
8. Training of operator personnel
9. Installation
10. Maintenance

The above tasks are further complicated when applied to cost and sched-

ule timetables. In a comparison, improvements in the following areas would be realized in a system built with equipment compatible in mechanical architecture, power and control vs. a system built using traditional integration techniques.

These improvements are in the areas of:

1. System conception because of pre-defined areas of compatibility
2. Development of special units because their design would begin with a defined form factor, power budget, and control structure
3. Integration and test
4. Documentation because of significant areas of commonality

Improvements affecting system cost and delivery would be realized regardless of whether or not comparable systems utilized "unified" system components completely or in part.

Watkins-Johnson believes the market is expanding in both generic and highly specialized communications and signal-intelligence receiving systems. It is believed that a significant market is evolving to where a framework of some of the more common receiving-system components may be created and standardized, thus justifying the manufacture of volume quantities, and resulting in the realization of additional cost savings.

## **System Definitions and User Problems**

The systems integrator is faced with a wide variety of commercially available communications and signal-intelligence equipment. This off-the-shelf equipment represents varying degrees of technology in areas of signal acquisition, demodulation, direction

finding, signal distribution and analysis.

Of the many considerations which must be addressed by today's systems designer, frequency coverage, demodulation requirements and analysis devices may be at the top of a list of system priorities. Even so, implementing control schemes to the degree of automation desired by the user may overshadow the technical risk and cost associated with hardware performance. For example, increasing evidence suggests that insurgent and terrorist organizations using commercially available state-of-the-art equipment are continually improving their ability to hide in different portions of the hf-to-uhf frequency spectrum, and are using various modulation schemes (amplitude modulation, frequency modulation, single-sideband voice, etc.). Such a threat may require a series of hf/vhf/uhf receivers, possibly special-purpose demodulators, as well as signal monitors and displays. Depending on the desired capability and size of the system, antenna, rf, IF and voice-switching capabilities may also be a requirement. Direction finders, recorders, time-code generators, hard-copy printers or other ancillary or storage equipment may be needed. The above hardware decisions are typically based on objective criteria. On the other hand, the decisions as to whether the operational mission requires local or remote control, or a unique compromise of the two, may add months to a program and significant costs to a system.

With today's technology there exists extensive possibilities for collection and surveillance techniques for use in communications acquisition type systems. The detection of insurgent and terrorist activities alone are compounded by an infinite volume of friendly as well as hostile transmis-

sions in domestic, political and military sectors. These activities clearly indicate a need for a wide variety of sheltered as well as man-transportable electronic support equipment. This equipment must be adaptive to a communications threat which exhibits daily its ability to rapidly change in dimension over a wide frequency range. The existence of today's changing communication techniques may bring an end to the one-of-a-kind system built with custom made components. In many applications, a once-conventional approach may be ready to step aside for the versatility of a new, rapidly deployable, user-reconfigurable design.

## Integration Problems

Communications and signal-analysis support components fail to meet the systems integrators expectations for many reasons. Many of the problems facing today's system integrators are categorized below:

### Cost

1. hardware
2. software development
3. integration

### Architecture

1. flexibility
2. inconsistent geometric shapes
3. sum of selected equipment exceeds available rack space
4. human engineering
5. ease of operation
6. geographically remote operation

### Power

1. system power consumption
2. dissipation of heat
3. power consumption dictating rack density
4. fans and blowers

### Environmental

1. atmospheric conditions
2. volume of air exchange
3. shock and vibration

## Control

1. programming language
2. man-to-machine interface
3. computing requirements
4. number of bus addresses
5. bus extenders
6. bus speed
7. simultaneous local/remote operation
8. multiple-independent bus structures
9. multiple on-line operator stations

## Reliability

1. duty cycles
2. MTBF performance
3. interconnections
4. heat

## Maintainability

1. documentation
2. MTTR performance
3. LRU definition
4. special tools and test equipment

## Training

1. installation, operation and maintenance

## General Solution

A unified system design would provide users with the ability to rapidly configure off-the-shelf, low-cost, low-power, high-performance receiving systems, and would overcome some of the limitations in the conventional rack-and-stack design approaches currently utilized in many system applications. This would lead to automated receiver-based systems which maximize operation, maintainability, provisioning considerations and future expansion. These new systems would be characterized by module compatibility in data control, power and all mechanical considerations. As a result of this unified-design approach, the configuration of any subsystem desired could be easily obtained, user-controlled and easily changed or upgraded to higher-level systems.

While emphasizing modularity, the design approach stresses interchangeability of modules and configuration freedom. Priority should also be placed on heat removal and distribution to ensure the absence of hot spots. Such emphasis would obviate the necessity for fans or external cooling. In addition, attention would be given to eliminating unnecessary wiring, cables and connectors, thus enhancing system reliability and minimizing system installation and module costs. Attention throughout this new system concept would be given to the use of compatible signal techniques and good mechanical and electrical design to insure EMC performance.

The unified design of the system would provide for the installation of a complementing series of radio receivers covering a broad frequency range. Other functional modules, such as signal distribution units, control/display modules, data storage modules (floppy discs or cassette tape), demodulation/signal-processing modules, direction finders and voice/data recording could be addressed. In addition, special modules would be more easily provided so that tasks unique to a particular mission could be easily integrated. These unique modules would be based on those unified system characteristics resulting in a design beginning with all size, power and control parameters predefined.<sup>1</sup>

## The WJ-9040 Unified System Approach

Although it may appear that the problems encountered in most communication systems only affect the systems integrator and end-user; this is not always the case. The "black-box" designer is often affected in ways which are less apparent. Redesigning or

1. To avoid noise and crosstalk problems, the power supply outputs chosen are +18.3, -18.3, and +8.2 volts, and are reregulated within each functional module to the industry standard, +15, -15, and +5 volts. This scheme also allows for distribution of the supply voltages within each module, with reregulation occurring at each major circuit assembly.

modifying standard products to fit into a new system, operate from a different control structure, or perform an added function consume both time and valuable design resources which could be better used. Watkins-Johnson Company formulated an approach which would help solve this problem. The objective was to develop a family of communication-system components which are based on a unified design and can be integrated, as required, to form a system.

The result was the WJ-9040 System, introduced by the CEI Division of Watkins-Johnson Company in 1983, and in production today. The WJ-9040 is a low-cost, compact, modularized family of receiving-system components which also includes displays, signal monitors, printers, direction finders and other ancillary equipment. The WJ-9040 System was designed to solve many of the problems addressed above by using modules which are compatible in mechanical architecture,

power requirements, and control structure. This results in a system that can be easily reconfigured by the end-user, and can be updated with new products at any time.

## System Design Philosophy

Designing a system of components meeting the above compatibility criteria required definition of a basic system building block. In the WJ-9040 System, this building block was chosen to be the equipment frame. The frame was designed around the standard 19-inch wide by 5.25-inch high rack-mountable format, and will accept any combination eighth, quarter, or half-sized functional modules, which slide into the frame from the front, as shown in Figure 2. In addition, the equipment frame accepts system support modules, such as the power supply, I/O control module and frequency-reference module at its rear. Although the equipment frame itself is fairly simple and serves only to mount modules and

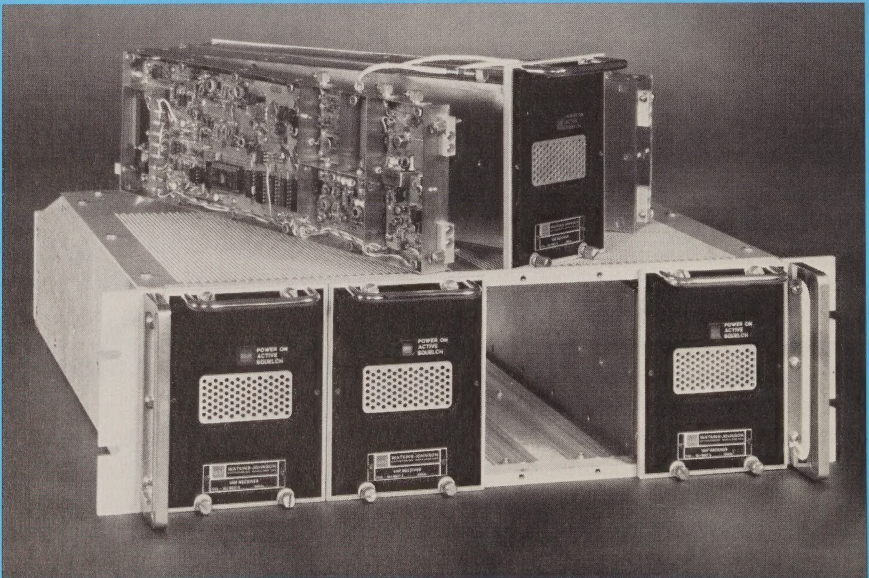

Figure 2. A frame consisting of four quarter-rack monitoring receivers which show the modular concept of both the system and the components themselves.

distribute power and control signals, it has clearly defined all-system modules in terms of size, power requirements and control structure.

## System Mechanical Considerations

In order to keep costs low and system versatility high, extensive consideration was given to the mechanical architecture of the system. Since all modules use a common packaging scheme, the frame will accept any combination of eighth, quarter, or half-rack modules. Interchangability of these units may occur at any time. These modules plug into the frame's backplane, which consists of a flexible PC board used for distribution of control, power, and certain I/O signals. To eliminate the need for rf-type connectors within the frame, and to allow for direct access to module inputs and outputs, a window or slot at the rear of the frame exposes all module connectors. The common control, power, and frequency-reference units mounted at the rear of the frame are also of a plug-in type design, thus allowing for easy maintenance. Since some system configurations do not require a frequency reference in every frame, this module is often replaced with other auxiliary or custom-designed components.

To keep total system weight down, the frame and functional modules utilize aluminum parts whenever possible. System costs are reduced by eliminating all point-to-point wiring within the equipment frame and functional modules. In addition, all units within the system are of a plug-in or modular construction to minimize MTTR.

## System Power Considerations

One of the major contributors to reliability problems in any component or system is excessive power consumption

and poor heat dissipation. In addition, the fans typically used for cooling generate both acoustic and electrical noise, and are prone to failure. To eliminate these problems, the WJ-9040 System design definition limits module power consumption. In addition, the system utilizes a single switching power supply which plugs into the rear of the equipment frame, and requires no cooling fans or blowers.

This scheme offers the following advantages. First, by mounting the supply at the rear of the frame, all heat generated by power supply inefficiencies is dissipated directly off of the supply, and not into the frame or modules. This, along with limited module-power consumption, eliminates the need for cooling fans. Secondly, the use of a single supply strictly defines all module voltage and power requirements. Finally, should a supply fail, replacement is quick and simple.

Although this approach offers many advantages, care must be taken in the overall system design to avoid certain pitfalls. To eliminate the need for a cooling fan, the modules themselves must be low in power consumption and the frame must lend itself to convection cooling. In addition, the different power requirements of the various modules and the numerous possible module combinations within a frame must not exceed the limits of the power supply and convection-cooling capabilities. Finally, switching noise and module-to-module interference through the supply lines must be minimized.

To avoid these potential problems, total frame and individual module maximum power limits are set. In addition, a maximum current limit for each of the dc supply lines is set for each size module (eighth, quarter or half rack). Ventillation holes are provided in the frame and modules in such a way as to

produce a "chimney effect," and facilitate convection cooling.

The standard system power supply is designed to operate from 90 to 130 Vac, or 180 to 260 Vac at 47 to 450 Hz. If dc operation is desired, the standard unit can be easily removed and replaced with a dc-to-dc converter. Although it can be argued that separate power supplies for each system module would prevent loss of an entire frame, the advantages offered by the common supply in the areas of cooling, power-supply efficiency, cost reduction, ease of replacement, and versatility result in lower overall system down time.

## System Control Considerations

As shown in Figure 3, the WJ-9040 control scheme is broken down into module, frame, zone, system and site levels through the use of a serial-star type network. The frame level contains up to eight modules, the zone level up to eight frames, the system level up to eight zones, and the site level up to eight systems. In most cases, system control can be accomplished at any of the levels with certain performance trade-offs occurring, dependent on the level chosen. This type of control scheme also offers the advantage of distributed system intelligence (increas-

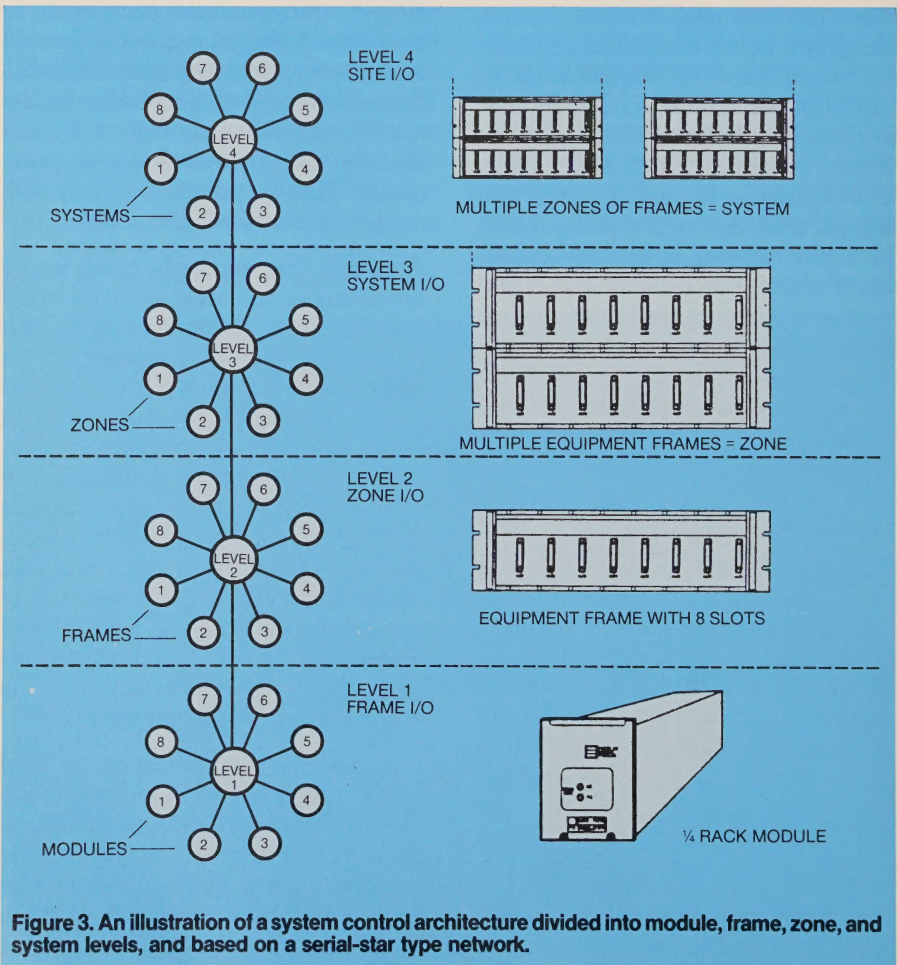

Figure 3. An illustration of a system control architecture divided into module, frame, zone, and system levels, and based on a serial-star type network.



ing with the addition of each frame) and multi-tasking within the system. A more detailed description of the control scheme will clarify the above.

Modules within the system are capable of being controlled either locally via a front panel, or remotely by a second module or system remote controller. Certain modules are intelligent (incorporate microprocessors), while others utilize discrete digital circuitry with no available memory. The choice depends on the function of the particular module. For example, an audio speaker module would typically not require remote control or a microprocessor, and a quarter-rack monitor/handoff receiver would not require local control or a front panel when used in an automated acquisition system. A half-rack hf or vhf/uhf receiver is provided a front panel, remote control capability, microprocessor control and memory, and the ability to control "handoff" or slave receivers. This allows the unit to be used in a "fail-soft" mode in the event of zone or system-control failure. All remotely controllable system modules use circuitry to identify their function to, and be controlled by the equipment frame.

The second level of control within a system is the frame level. The I/O control module in the frame is responsible for system "housekeeping" functions, such as module identification, routing of control signals from sources within or outside of the frame, and the routing of certain output signals from the functional modules. This is all accomplished through the use of a low-power CMOS NSC800 microprocessor equipped with 56 kbytes of EPROM and 8 kbytes of RAM (both battery backed-up and non-volatile).

Communication between the I/O control module and individual functional modules occurs through the use

of clock, strobe, enable, and serial data-in and data-out lines operating at 40 kbaud and 21 kbaud, respectively. These lines are used to send all system control signals to the modules and to receive identification data from the modules. A separate set of eight lines referred to as "polled input/outputs" are used to route information, such as audio, signal strength, signal presence, etc. from a particular module to the I/O module for use by other equipment frames or operator positions. It should be noted that these inputs and outputs are also available for "hard-wired" connection directly at the functional module.

The next level of control, referred to as the zone level, is composed of up to eight frames. Each of these frames communicates with the zone interface module through a serial coaxial cable operating at 156.3 kbaud. This communications link utilizes checksums and parity for error checking to insure reliability of the link. The zone interface serves as a buffer to pass communication between frames, or from a system controller to any frame. Although not implemented at this time, this scheme can be expanded to the system level (eight zones) and the site level (eight systems) to allow for control of up to 4096 individual functional modules.

## Control Trade-offs

As previously mentioned, control of the system can occur at any level. The functional module, equipment frame, or zone can be controlled via a standard IEEE-488 or RS-232 interface. This effectively allows for a multitude of different control schemes and architectures, each with its own attributes. One extreme is system control at the functional module level (for example, IEEE-488 or RS-232 interface directly

to a half-rack receiver). This approach results in the fastest control response time, since frame and zone-level control overhead is eliminated, but puts added burdens on the system controller, and complicates overall system control because a separate address-and-control cable must be used for each module. The opposite extreme is to control the system at the zone level (or higher) using a single point of interface. Although response time is slower, this scheme may utilize the distributed intelligence of the system to offer many advantages which offset the need for fast module response, and could allow for total system control using a single address, cable, and interface.

A simple example of control at the module level is given below. In a typical acquisition system composed of scanning receivers and direction finders, it may be desirable to only process or report signals arriving with a certain line-of-bearing (LOB) at a certain time of day. Using control at the functional module level (typical of most systems), the system controller or computer is connected to the receiver, direction finder, and system clock. As the scanning receiver acquires signals, it alerts the system controller which, in turn, activates the direction finder and reads back a bearing. The system controller then performs LOB and time-of-day checking routines to determine whether to log and report the signal. The process is then repeated with the system controller sending the receiver a new frequency.

In the case of control at the zone or frame level, the system controller is only required to initialize the system (set up frequencies) and wait for the correct response. The I/O control module handles all communication between the receiver and direction finder, performs the proper LOB and time-of-day checking routines, and only

then alerts the controller to process a signal (or group of signals). This scheme allows the controller to perform other system functions until otherwise alerted. Although this approach may require more time for communication between modules and the controller, the communication occurs less often and the controller is far less burdened with individual tasks. (This concept can be taken to its maximum limit by adding a printer module, expanding module level software, and using the module front panels to enter system parameters, thus eliminating the need for a system controller or computer.)

Other system scenarios may require rapid communication between the controller and modules and, as previously mentioned, this can be accomplished in the usual manner. The prime advantage of the WJ-9040 System is that it allows either extreme by offering control entry at any point or level within the system. As system requirements change, the equipment and control structure can be reconfigured as needed, with changes occurring only in software, and not in hardware as is common with most systems. Other advantages of this approach include the possible downloading of software within the system to the I/O control module. This results in ease of system adaptation to changing environments.

## **System Functional Modules**

The WJ-9040 System is composed of functional modules which include receivers, demodulators, direction finders, switching units, displays, printers, and other ancillary equipment. Actual design of the modules has been simplified, since size, power requirements, and control structure were all previously defined. The modules described below are a sample of those available, and new units are being developed on a continuing basis.

The WJ-9040 System is primarily intended to be used for signal acquisition, monitoring and analysis, and is, therefore, based around hf, vhf/uhf, and microwave receivers. Major system components include quarter-rack, remotely controlled hf (5 kHz to 30 MHz) and vhf/uhf (20 to 512 MHz) receivers, and half-rack, front-panel controllable versions of these receivers. The additional space provided by the half-rack enclosure allows for options such as preselectors and FSK demodulators in the case of the hf receiver, and frequency extenders (to 1400 MHz) in the case of the vhf/uhf unit. The half-rack receivers include ample memory for special software routines, and can be remotely controlled through the frame, or directly, by a standard interface. The units include a keypad and an alphanumeric front-panel display for ease of control, and are capable of memory channel storage and scanning. For smaller system applications, the half-rack receivers are capable of controlling (through the I/O module) other quarter-rack receivers (either hf or vhf/uhf), thus allowing for full 5 kHz to 1400 MHz frequency coverage in three quarters of a frame, as shown in Figure 4. This feature also results in a compact acquisition/handoff system

using a half-rack master receiver and up to 34 quarter-rack slaves.

Figure 5 shows the block diagram of the single-frame system composed of a half-rack 20 to 1400 MHz receiver, a quarter-rack 5 kHz to 30 MHz receiver (being controlled by the half-rack unit), and a quarter-rack speaker panel. The figure also clearly illustrates the frame architecture described earlier in this article. In this example, one of the frame's polled I/O lines is used for receiver audio, and is routed to the speaker panel automatically when either receiver is being controlled. Remote control is possible through an IEEE-488 or RS-232 interface card mounted in the I/O control module (IOM108). An option slot at the rear of the frame is used for a site-lockable frequency reference module which supplies the receiver synthesizers with the proper reference signal.

For low cost, fixed monitoring or hand-off applications, a series of multioctave (20 to 100, 100 to 180, 180 to 300 or 220 to 440 MHz) quarter-rack receivers are also available.

All receivers in the system are remotely controlled in the same manner, thus easing the burden placed on the system software designer, and all half-rack

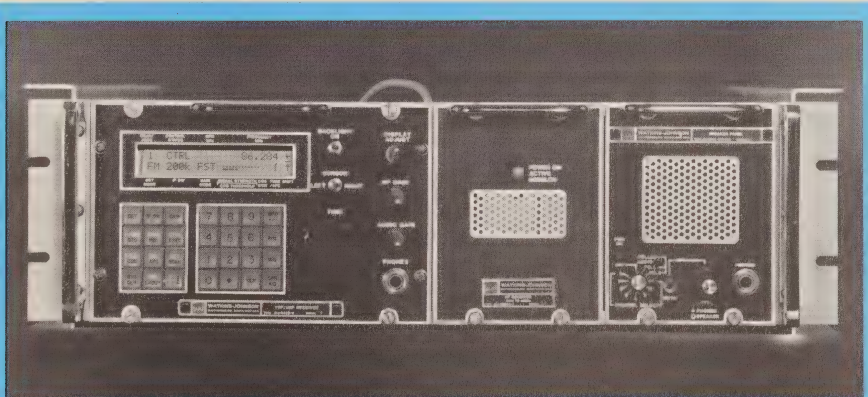
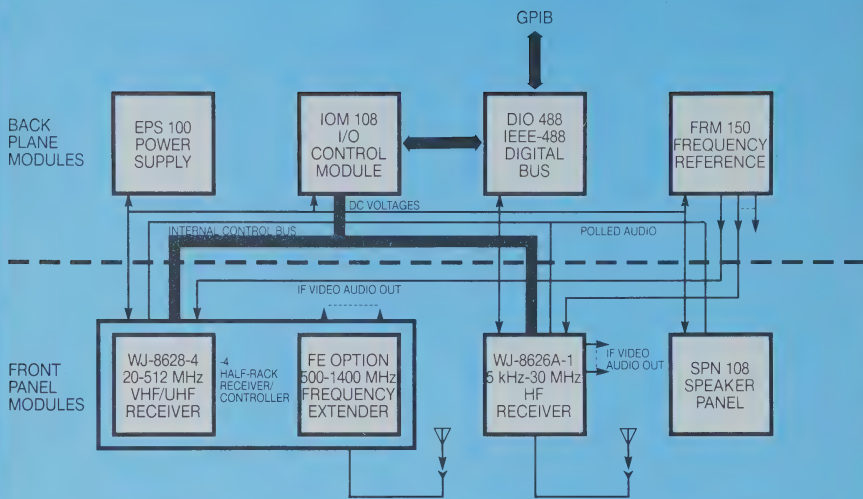

Figure 4. Pictorial view of a 5 kHz to 1400 MHz single-frame receiving system composed of a half-rack 20 to 1400 MHz receiver, a quarter-rack hf receiver, and a speaker panel.



- DC POWER AND CONTROL BUS SUPPLIED THROUGH BACK PLANE CONNECTORS
- POWER SUPPLY, DIGITAL CONTROL AND REFERENCE MODULES DROP-IN DESIGN FOR EASY MAINTENANCE
- FUNCTION MODULES INSTALL FROM FRONT, NOT SLOT DEPENDENT
- HALF-RACK RECEIVERS AND IOM CONTAIN DISTRIBUTED PROCESSING POWER FOR HIGHER AUTOMATION
- IOM HOUSE KEEPS FRAME AND ALLOWS SMOOTH PASSING OF CONTROL FROM HALF-RACK RECEIVER TO EXTERNAL GPIB AND BACK

**Figure 5. Block diagram of a 5 kHz to 1400 MHz receiving system showing equipment frame architecture, and based on a unified-design approach.**

receivers use identical front panels, resulting in ease of operator training. The units are all based on a low-power design and typically draw only 13 to 16 watts of power. Their compact size allows for the use of four receivers in the space typically required by one unit of older design. Since the units plug into the front of a frame, replacement or reconfiguration is an easy task. The I/O module within the frame keeps track of which type receiver is installed, and then utilizes the proper software required for control.

Microwave coverage (1 to 18 GHz) within the system is achieved by the use of 500-MHz wide, fixed downconverters which convert segments of the

spectrum to the 500 to 1000 MHz band, where tuning in 10-kHz steps occurs. The signal is then passed to a demodulator module which includes group-delay equalized bandwidths up to 50 MHz wide. The scheme is intended for use in monitoring applications where the frequency of the signal of interest is known, and stringent performance is required. The use of a downconverter eliminates the need for YIG-tuned devices, and results in very fine tuning steps, low phase noise, and high-noise power ratios.

## Larger Systems

Larger systems require the use of other functional modules to perform signal

routing, analysis, and further processing. Units designed to date include a half-rack direction finder which operates in conjunction with vhf/uhf receivers, and is based on a proven psuedo-doppler design, and signal monitors (wideband IF panoramic displays) for use with hf or vhf/uhf receivers. The signal monitor outputs dc voltages to a general purpose, quarter-rack CRT for display. For more advanced analysis applications, an FFT type signal monitor and automatic modulation recognizer can be included in the system. Demodulators operating

at 21.4 MHz or 160 MHz are available, as are speaker panels, printers, and switching units for distribution of audio, video, IF or rf signals. These switching units allow for the custom design of remote-controlled systems at both a low recurring cost and minimal integration or development cost.

Figure 6 shows the block diagram of a 5 kHz to 1400 MHz acquisition, handoff, monitor and analysis system composed of four equipment frames. The system includes half-rack hf and half-rack vhf/uhf scanning acquisition

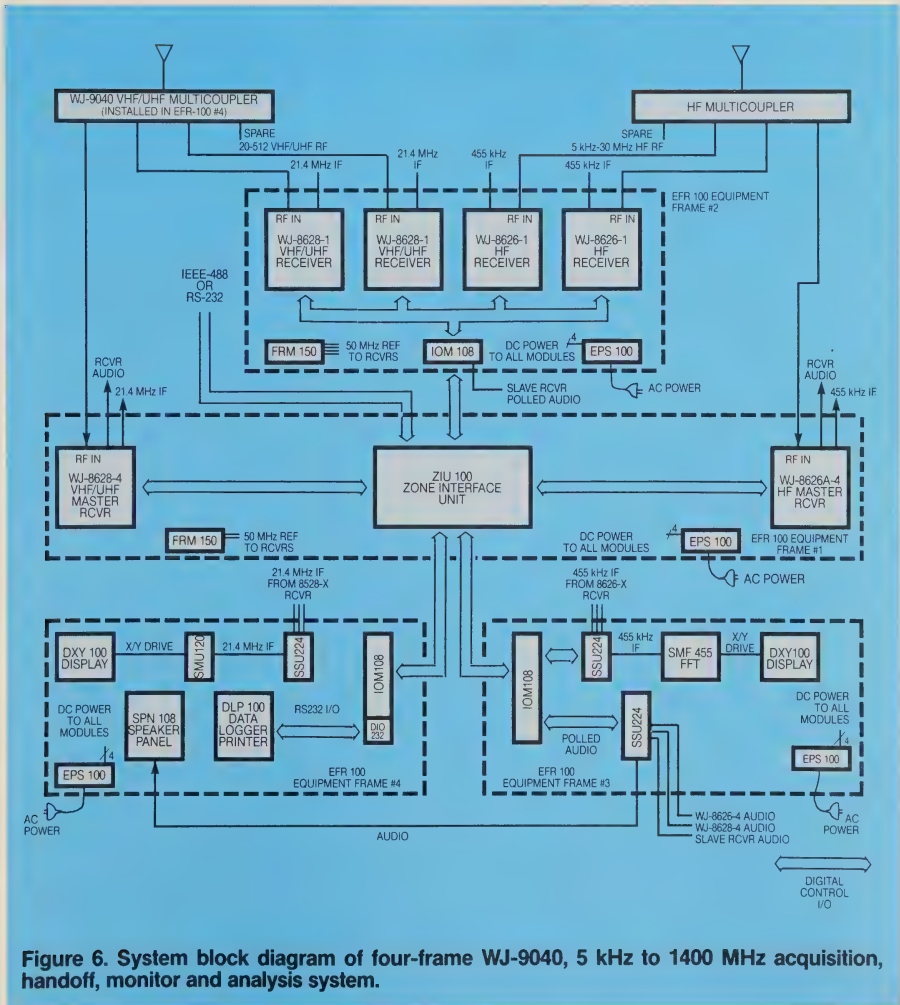

Figure 6. System block diagram of four-frame WJ-9040, 5 kHz to 1400 MHz acquisition, handoff, monitor and analysis system.

receivers; two quarter-rack hf and two-quarter rack vhf/uhf handoff and monitoring receivers; a conventional analog vhf signal monitor and display; an FFT-type hf signal monitor and display; three switching units for routing of receiver wideband IF and audio signals; a speaker panel; and a printer. A front view of the system is shown in Figure 7. Control of the system is via the half-rack receiver front panels or remotely, through a single IEEE-488 or RS-232 interface connected to the system's zone interface module. The system is a good example of how the unified-design approach used in the

WJ-9040 family of components results in ease of system integration and control, compact size, low power consumption, low overall development costs and, most importantly, the ability to reconfigure or upgrade the system at any time.

### Future and Custom Development

Future system development will be directed in the areas of software, digital-signal processing for high-speed acquisition and monitoring, and telecommunications. Units soon to be

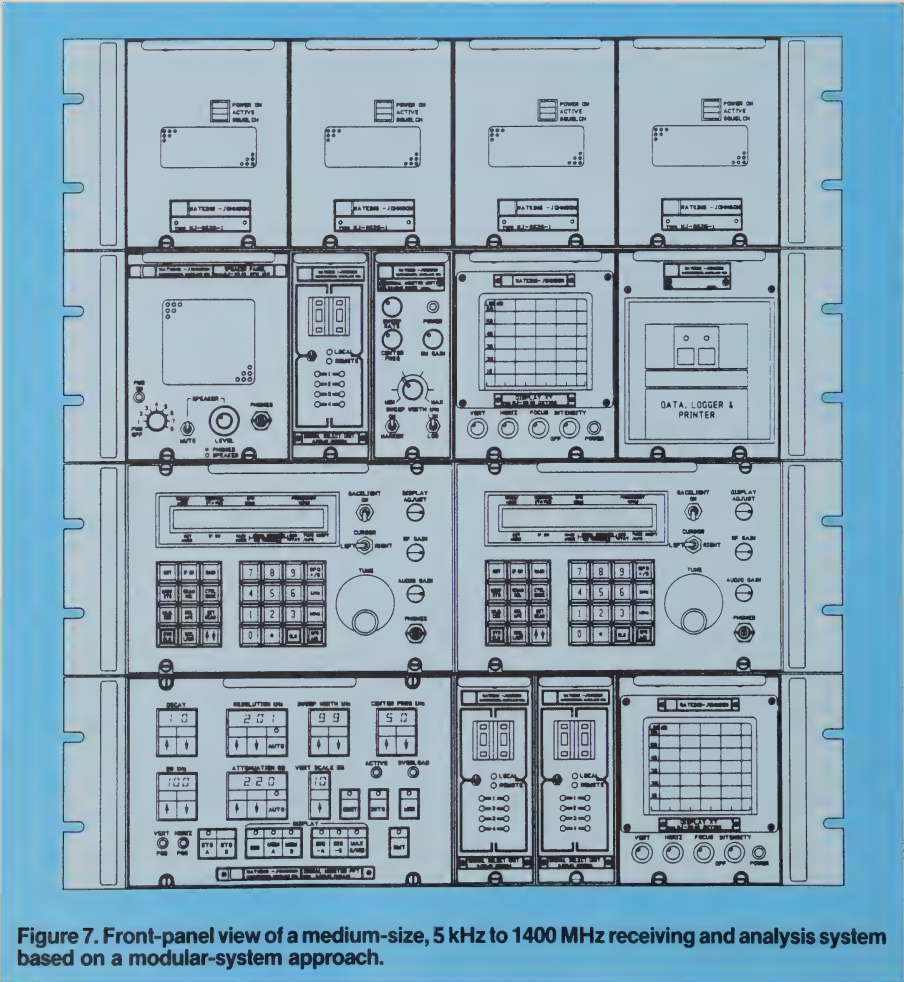

Figure 7. Front-panel view of a medium-size, 5 kHz to 1400 MHz receiving and analysis system based on a modular-system approach.

released include a PCM demodulator for T1 or CEPT formatted signals, and a 2.5-MHz wide FFT analyzer operating at 21.4 MHz.

Although the need for custom-designed components is reduced in the WJ-9040 System, it is invariably a fact of life—particularly in the area of software. The concept of distributed intelligence, the use of memory partitioning, and ample extra memory within the system allow for the development of custom software, which eases the burden placed on system integrators. In addition, custom hardware modules can be designed at a low cost, since size, power requirements, and control structure are defined.

## **Solutions To The Systems Problem**

The use of modules or components which are common in mechanical architecture, power requirements, and control structure has helped eliminate many of the problems facing the systems integrator. These problems are listed in the beginning of this article, and some of them, along with their solutions, are summarized below.

In terms of architecture, the use of modules which fit into a standard rack-mountable frame, and can be interchanged at any time has helped in the areas of mechanical integration. The compact size of the modules themselves has reduced overall system size and weight.

The low power consumption of the system components has improved overall system reliability, eliminated the need for fans, and eased the systems designer's burden with regard to rack configuration, airflow calculations and blower requirements. In mobile applications, lower power consumption reduces generator requirements and enclosure

ventillation problems. The use of common modular supplies minimizes system MTTR, and the ability to select input voltages or easily install a dc-to-dc converter allows for adaptation to changing operational environments.

The use of a common and flexible control architecture within the system allows for direct connection to each module for high-speed applications, or connection to a single point in the system through the use of a standard interface. The system integrator's software development time and computer requirements are reduced by the use of distributed intelligence at the module, frame, and zone levels of the system.

Overall systems costs have been lowered in a number of ways. At the module level, low-cost design techniques have been used, and the need for mounting brackets, power supplies and cooling fans has been eliminated. Many of the system components which were custom designed in the past are no longer required, and those which must be so designed, can be, at a lower cost. The costs of integrating equipment has been greatly reduced by the use of modules which are compatible in control, size, and power requirements. Since the interface to, and operation of, many of the modules is identical, training costs are lower. Logistics and spares costs are reduced through the use of common circuitry within the system at the board, assembly, and major functional module level. System downtime and repair costs are reduced, since major system components can be easily removed and replaced.

One of the major advantages in the use of the WJ-9040 System is the ability to upgrade, modernize, or change the system at any time in its lifecycle at a cost much lower than that of systems using conventional designs. This point

must be considered when calculating the overall cost of a system over its entire lifetime. In addition, as mission requirements change, the system can be easily adapted to meet new goals in a minimal amount of time, and at a greatly reduced cost. For example, the ability to replace a quarter-rack hf receiver with a vhf/uhf receiver, or fill an empty slot with a signal monitor, without major changes in software, interface cables, size, or power requirements is an important attribute.

## **Conclusion**

Although no one system concept or family of components can completely solve all of the problems facing today's system integrators and end users, the unified design approach used in the WJ-9040 System reduces many of them.

The integration of any system requires tradeoffs, some of which were addressed in this article, and no system integrator should be expected to purchase all components from one source. However, the design of a system using modules which are common in mechanical architecture, power requirements, and control structure results in major advantages in the areas of overall system cost, size, and flexibility.

## **Acknowledgement**

The authors would like to thank all those co-workers who have contributed in the design, and customers who have aided in the development of the WJ-9040 System over the last three years. Special thanks to Bob Glaz and Bob Pitta for their help and editing expertise.



## References

1. Kenneth W. Bach, Robert J. Lenard, and Terrance K. Sullivan, "A Unified Design For Modular, Compact C<sup>3</sup>I Subsystems," Proceedings, Watkins-Johnson Company Technical Symposium, October, 1982.
2. Watkins-Johnson Company, "WJ-9040 Modular Receiving System — Designer's Handbook," October, 1984.

## Authors:

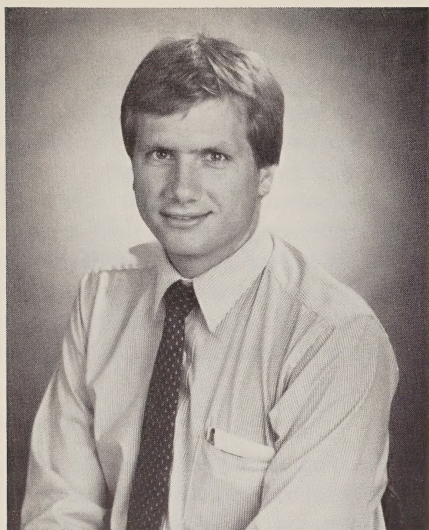

### **Richard M. Lober**

Mr. Lober is Head of the Strategic Equipment Engineering Section at the CEI Division. He is currently responsible for directing electrical and mechanical engineers in the design of new modules for the WJ-9040 System and other hf through microwave receiving system components, including the WJ-8628 VHF/UHF Acquisition Receiver.

Mr. Lober's past positions include Head of VHF/UHF Receivers, and Member of the Technical Staff in the R&D Department of the CEI Division. He was responsible for the design of portion of the WJ-8627 series VHF/UHF receivers and the WJ-8626 series HF receiver.

Mr. Lober received his B.S.E.E. and M.S.E.E. degrees at the University of Illinois, Urbana-Champaign, where he specialized in rf/microwave design and acted as a lab instructor while in graduate school. He is a member of Eta Kappa Nu and Tau Beta Pi.

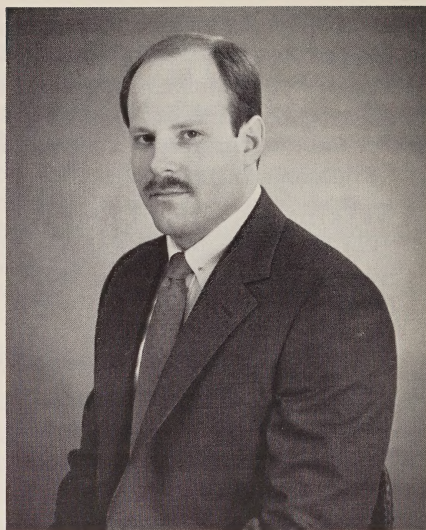

### **Scott A. Frager**

Scott A. Frager is Head of the Strategic Receiving Programs Section at the CEI Division. He is currently responsible for the marketing and manufacture of WJ-9040 System components. Since the introduction of the WJ-9040 concept in 1983, Mr. Frager has performed various program engineering tasks. These tasks include developing proposal strategies, managing program costs and schedule performance, and the transition of new products to manufacturing.

Mr. Frager's past positions include the successful management of the WJ-8718 HF Receiver product line. During that time, the WJ-8718 receiver achieved its peak volume production quantities while completing a several-thousand receiver, five year contract, ahead of schedule and within program cost parameters.

Mr. Frager has attended Shepherd College in West Virginia and York College of Pennsylvania. He is currently attending the University of Maryland.

## Notes

WATKINS-JOHNSON COMPANY  
3333 HILLVIEW AVENUE  
PALO ALTO, CA 94304  
(415) 493-4141

BULK RATE  
U.S. POSTAGE  
PAID  
PERMIT NUMBER  
173  
MILPITAS  
CALIFORNIA



WATKINS-JOHNSON

## Facility Locations

### United States

#### CALIFORNIA

Watkins-Johnson  
3333 Hillview Avenue  
Palo Alto, 94304  
Telephone: (415) 493-4141

Watkins-Johnson  
2525 North First Street  
San Jose, 95131  
Telephone: (408) 435-1400

Watkins-Johnson  
440 Kings Village Road  
Scotts Valley, 95066  
Telephone: (408) 438-2100

#### MARYLAND

Watkins-Johnson  
700 Quince Orchard Road  
Gaithersburg, 20878  
Telephone: (301) 948-7550

### International

#### UNITED KINGDOM

Watkins-Johnson  
Dedworth Road  
Oakley Green  
Windsor, Berkshire SL4 4LH  
Telephone: (07535) 69241  
Telex: 847578  
Cable: WJUKW-WINDSOR

#### ITALY

Watkins-Johnson S.p.A.  
Piazza G. Marconi 25  
00144 Roma-EUR  
Telephone: 592 45 54  
591 25 15  
Telex: 612278  
Cable: WJ ROM I

#### GERMANY, FEDERAL REPUBLIC OF

Watkins-Johnson  
Keferloher Strasse 90  
8000 Muenchen 40  
Telephone: (089) 35 97 038  
Telex: 509401  
Cable: WJDBM-MUENCHEN

Watkins-Johnson  
Deutschherrenstrasse 46  
5300 Bonn 2  
Telephone: (228) 33 20 91  
Telex: (886) 9522  
Cable: WJBN-BONN

The Watkins-Johnson *Tech-notes* is a bi-monthly periodical circulated to educational institutions, engineers, managers of companies or government agencies, and technicians. Individuals may receive issues of *Tech-notes* by sending their subscription request on company letterhead, stating position and nature of business to the Editor, *Tech-notes*, Palo Alto, California. Permission to reprint articles may also be obtained by writing the Editor.